

Denominazione:

Nuova 500, Normale, Economica, Trasformabile, Tetto Apribile,
Nuova 500 Sport.

Periodo di produzione:

novembre 1959-marzo 1961

Note specifiche:

Adeguamento nuovo Codice della Strada

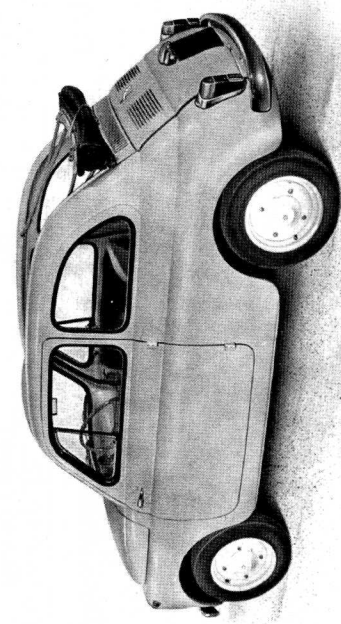
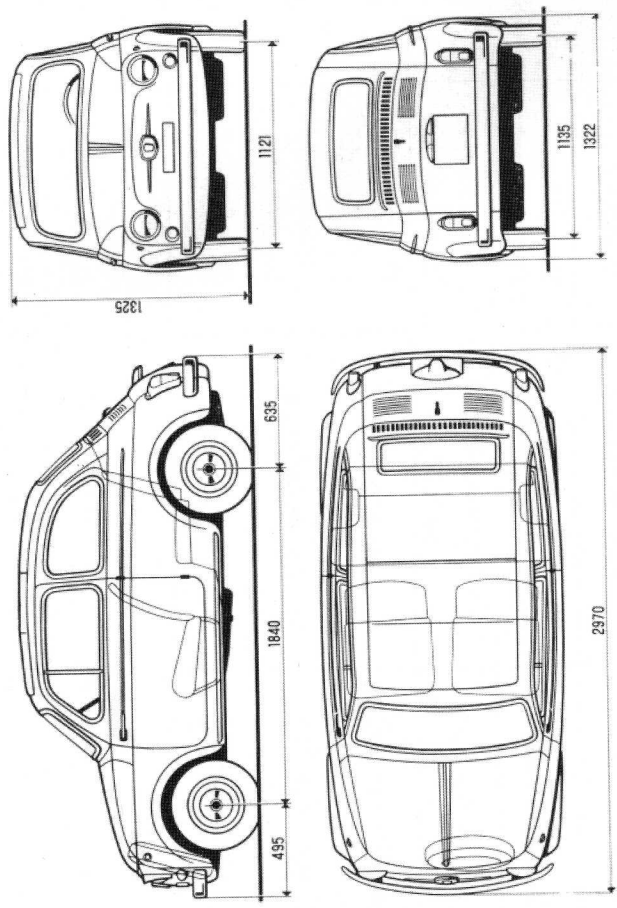

Nuova 500 Trasformabile

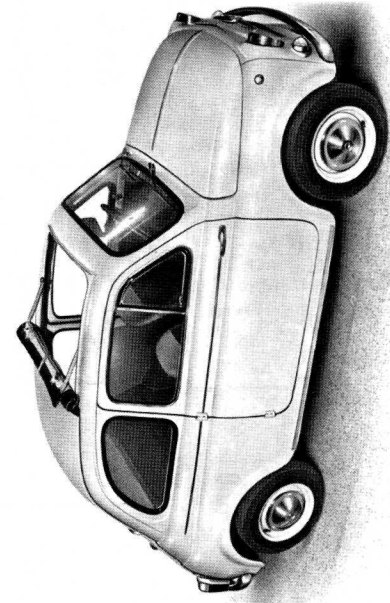

Nuova 500 Tetto apribile

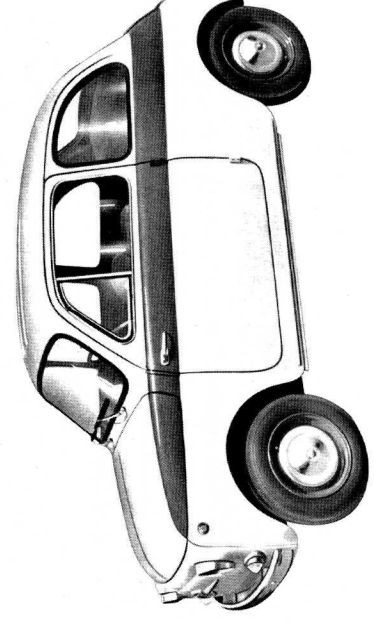

Nuova 500 Sport chiusa

